

SERIES Mini -QMA CONNECTORS

DESCRIPTION

The Mini-QMA, designed by James Qu at Anoisn in 2006, is the smallest QMA connector on the market to date. The shortened length of the Mini-QMA jack makes this rugged, low profile connector an ideal solution for traditional Quick Lock SMA applications that have space constraints: particularly those that require panel or PCB mounting. Additionally, Mini-QMA offers 10x faster mating/de-mating than SMA, conserves space by eliminating the need for torque wrench clearance, and allows for the cable to be rotated 360° after the connector has been attached.



CONTENT

Description.....	14
Interface Dimensions	14
Characteristics	15
Cable Connectors.....	16
Panel Receptacles.....	17
In Series Adapter	18
Between Series Adapters	19
Termination	20

INTERFACE DIMENSIONS

Plug (male)

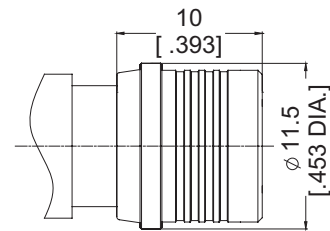

Jack (female)

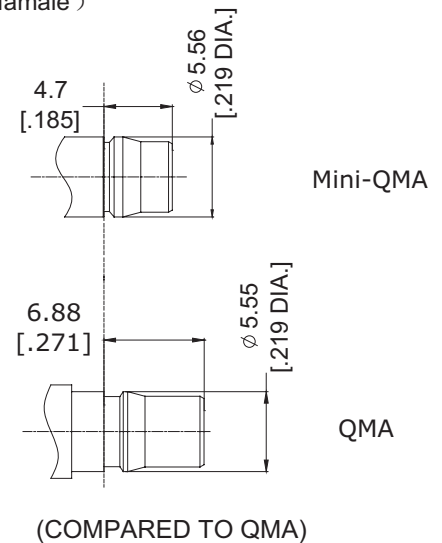

CHARACTERISTICS

ELECTRICAL	REQUIREMENTS
Impedance	50 Ω
Frequency range	DC to 18 GHz
Dielectric Withstanding Voltage	1000 V rms 50 Hz, sea level
Working Voltage	≤ 480 V rms 50 Hz, sea level
VSWR	Straight connector, .141": ≤ 1.25 (DC~18 GHz) Straight connector, RG316: ≤ 1.23 (DC~6 GHz) Right angle connector, .141": ≤ 1.40 (DC~18 GHz) Right angle connector, RG316: ≤ 1.30 (DC~6 GHz)
Insulation Resistance	5×10^3 M Ω min.(initial)
Power Handling	150 W @ 2.5 GHz typical
Contact Resistance	
- Center contact	3.0 m Ω max.
- Outer contact	2.5 m Ω max.
Passive Intermodulation	-120 dBc @ 1.8 GHz 2x20 W static
RF-leakage	
- DC to 3 GHz	- 80 dB min
- 3 to 6 GHz	- 70 dB min

MECHANICAL	REQUIREMENTS
Mating Characteristics	
- Engagement Force	25 N typical
- Disengagement Force	30 N typical
Interface Retention Force	100 N min.
Durability (Mating Cycles)	200 min.

ENVIRONMENTAL	REQUIREMENTS
Temperature Range	-40°C to +85°C
Thermal Shock	IEC 60169-1 16.4 (-40°C/ +85°C)
Corrosion	IEC 60169-1 16.7 (48 hrs)
Damp Heat	IEC 60169-1 16.3 (96 hrs) steady state
Vibration	IEC -68-2-64 random 5-20Hz: 1.29 (m/s ²) ² /Hz 20-500Hz -3dB/octave
Dust & Moisture protection	IEC 60529
IP Rating interface	IP 68

Note: The above characteristics are typical but may not apply to all connectors.

CABLE CONNECTORS

Straight Cable Plugs (male)

> for semi-rigid cables

Part No.	Description
ANO 2811-2002	Mini-QMA straight plug solder for semi-rigid.141/ RG402

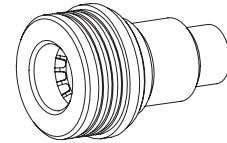
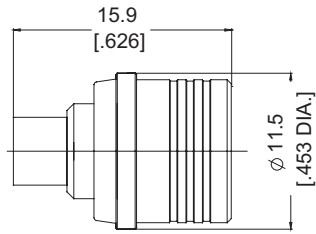

> for flexible cables

Part No.	Description
ANO 2811-2001	Mini-QMA Straight plug crimp for RG316/RG178/LMR100

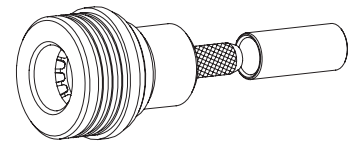
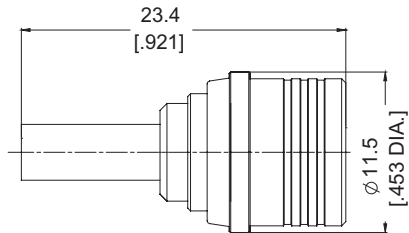

> for flexible cables

Part No.	Description
ANO 2811-2009	Mini-QMA Straight plug crimp for RG58/LMR195/LMR200

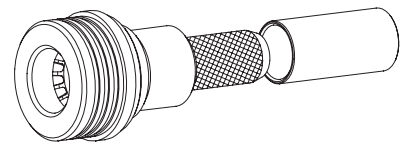
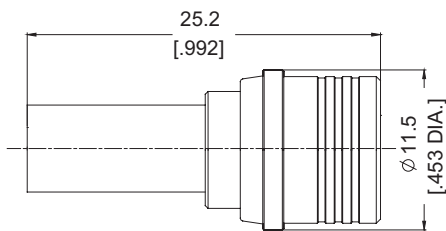

Right Angle Cable Plugs (male)

> for semi-rigid cables

Part No.	Description
ANO 2821-2008	Mini-QMA Right Angle plug solder for semi-rigid.141/ RG402

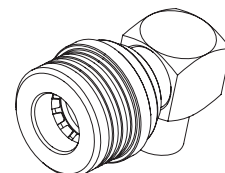
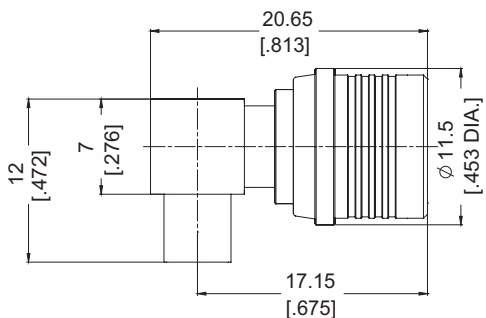

Straight Cable Jacks (female)

> for semi-rigid cables

Part No.	Description
ANO 2812-2004	Mini-QMA straight jack solder for semi-rigid.141/ RG402

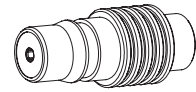
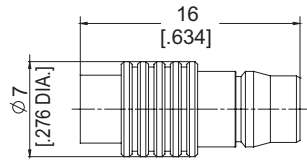

Straight Bulkhead Cable Jacks (female)

> for semi-rigid cables

Part No.	Description
ANO 2812-1005	Mini-QMA Straight jack bulkhead solder for od=1.13

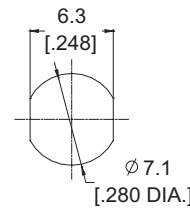
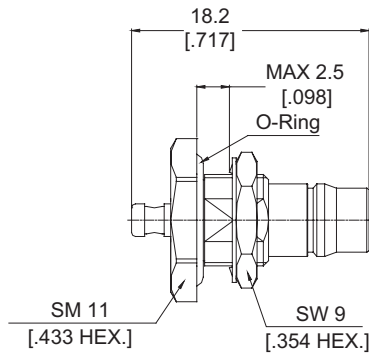

Mounting Dimensions

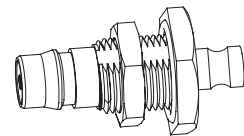

> for semi-rigid cables

Part No.	Description
ANO 2812-1003	Mini-QMA jack bulkhead solder for semi-rigid .086/RG405

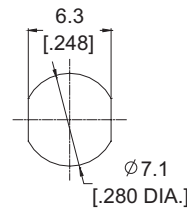
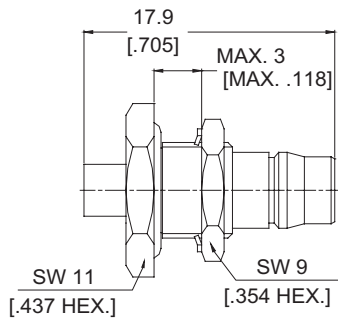

Mounting Dimensions

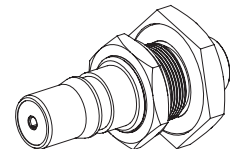

PANEL RECEPTACLES

> 2 Hole Panel

Part No.	Description
ANO 2812-3006	Mini-QMA Straight jack receptacle 2 hole Flange

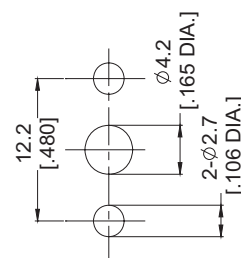
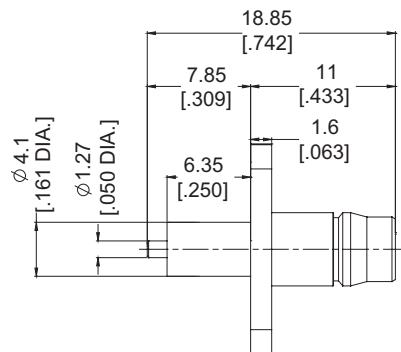
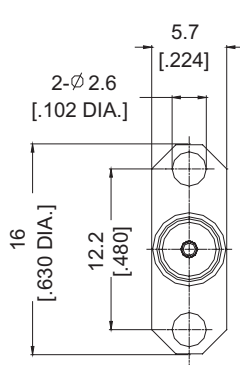

Mounting Dimensions

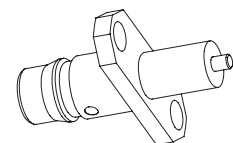

> 4 Hole Panel

Part No.	Description
ANO 2812-3007	Mini-QMA Straight jack receptacle 4 hole Flange

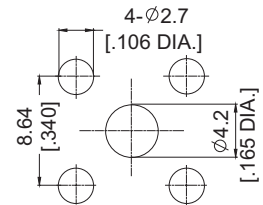
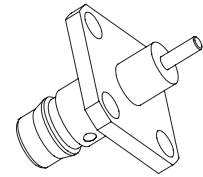
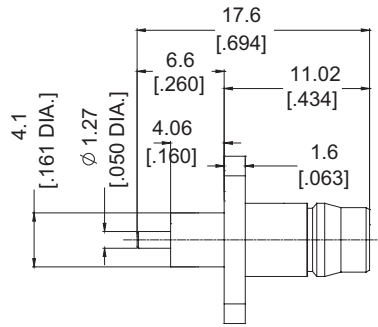
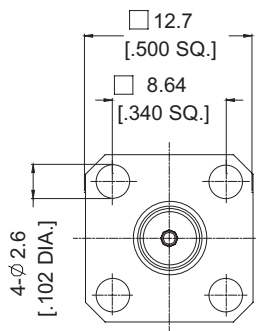

Mounting Dimensions

IN SERIES ADAPTER

> Mini-QMA / Mini-QMA

Part No.	Description
ANO 281-281-1048	Mini-QMA male- Mini-QMA male

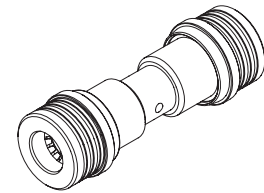
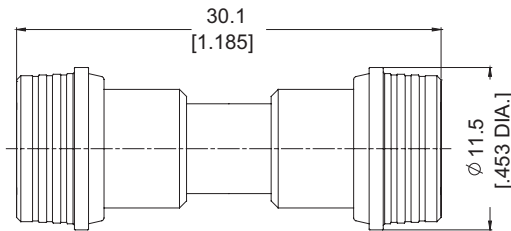

> Mini-QMA / Mini-QMA

Part No.	Description
ANO 282-282-1049	Mini-QMA female- Mini-QMA female

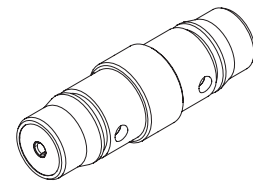
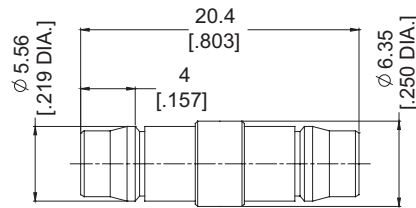

> Mini-QMA / Mini-QMA

Part No.	Description
ANO 281-282-1050	Mini-QMA male- Mini-QMA female

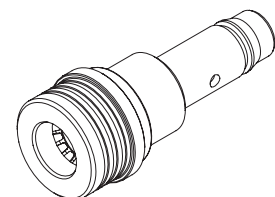
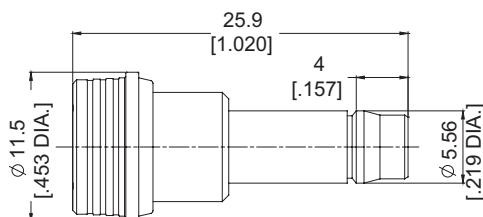

BETWEEN SERIES ADAPTERS

> Mini-QMA / SMA

Part No.	Description
ANO 282-212-1052	Mini-QMA female to SMA female

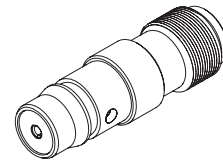
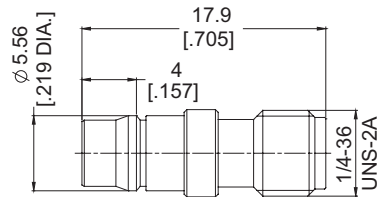

> Mini-QMA / SMA

Part No.	Description
ANO 281-212-1053	Mini-QMA male to SMA female

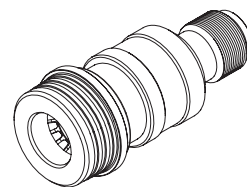
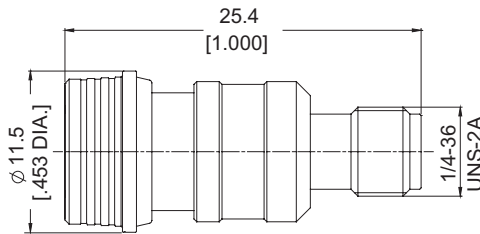

> Mini-QMA / SMA

Part No.	Description
ANO 281-211-1051	Mini-QMA male- SMA male

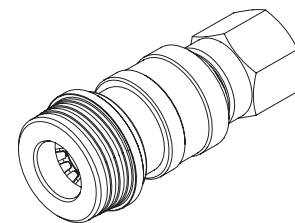
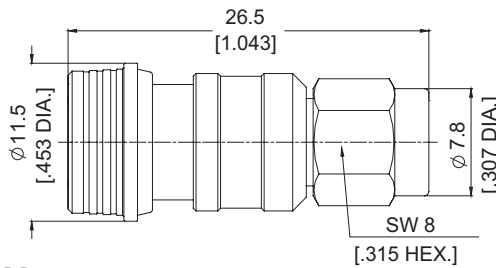

> Mini-QMA / SMA

Part No.	Description
ANO 282-211-1054	Mini-QMA female- SMA male

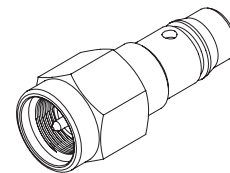
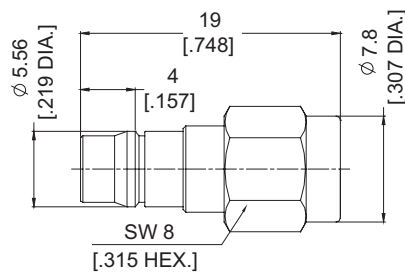

> Mini-QMA / N

Part No.	Description
ANO 282-512-1056	Mini-QMA female to N female

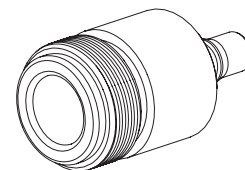
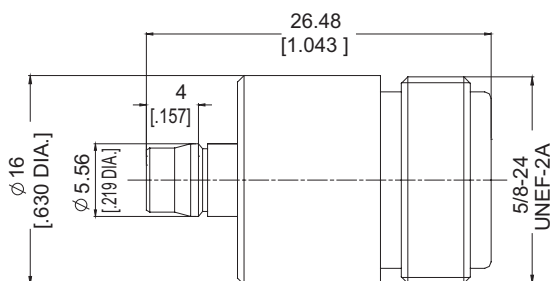

> Mini-QMA / N

Part No.	Description
ANO 281-512-1057	Mini-QMA male to N female

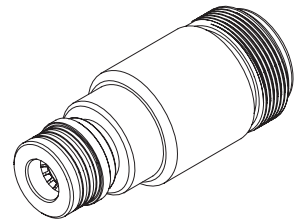
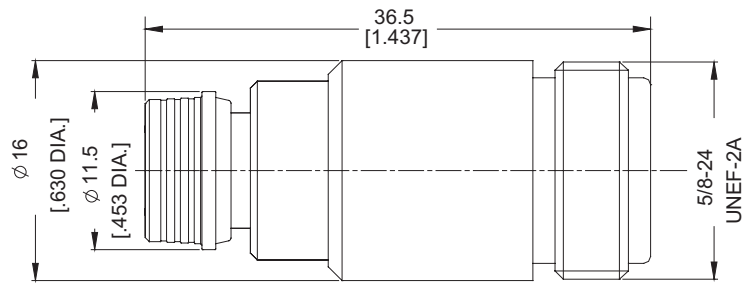

> Mini-QMA / N

Part No.	Description
ANO 281-511-1055	Mini-QMA male- N male

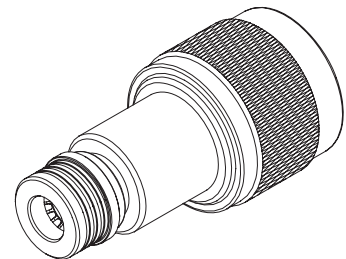
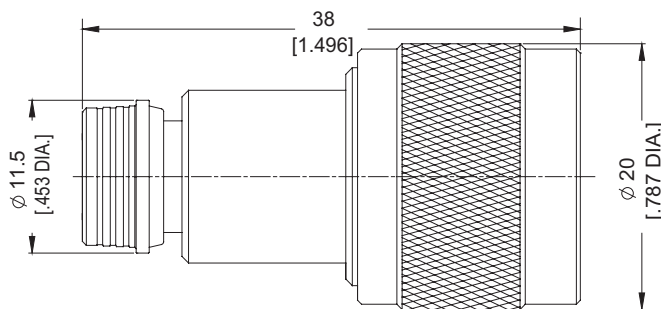

> Mini-QMA / N

Part No.	Description
ANO 282-511-1058	Mini-QMA female- N male

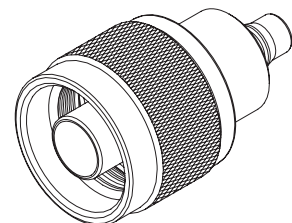
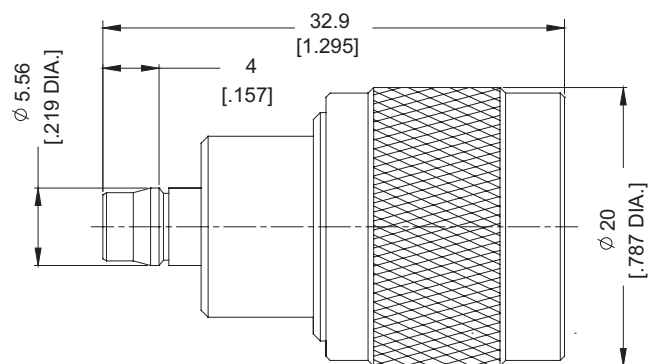

TERMINATION

> Low power 1 to 2W CW, 100W peak

Part No.	Description
ANO 281-701	RF Termination, Mini-QMA Male, 1W, 0-6GHz

